

Platzieren Sie Ihr Tablet in die Klemme.



Für Schäden an montierten Geräten wird keine Haftung übernommen. Informieren Sie sich unbedingt vor dem Gebrauch beim Hersteller Ihres Gerätes über die Verwendbarkeit dieses Zubehörproduktes.

Hiermit erklärt die XLayer GmbH, dass sich die **XLayer Tablet-Halterung für Kfz-Kopfstützen** in Übereinstimmung mit den grundlegenden Anforderungen und den übrigen einschlägigen Bestimmungen der erforderlichen Richtlinien befindet. Die entsprechende Konformitätserklärung kann unter service@xlayer.de angefordert werden.

User Guide

Tablet holder for car headrests

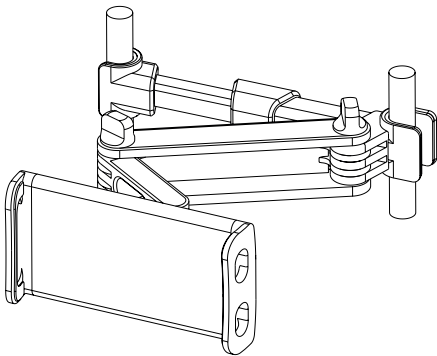

Thank you for purchasing the XLayer Tablet Holder for Car Headrests. The XLayer Tablet Holder is mounted and ready for use in seconds. Whether on a business trip or on holiday - the Tablet Holder ensures the best entertainment for adults and children alike.

Contents

1 Tablet Holder, 1 Headrest Holder, 1 User Manual

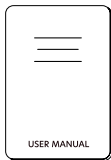
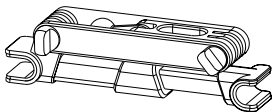
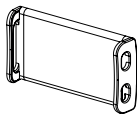

Instructions

- Assembling the mounting bracket for car headrests.**
Attach the tablet clamp to the telescopic holder.

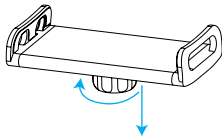

Remove the screw from the tablet clamp.

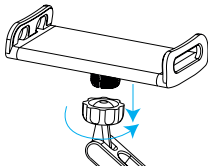

Insert the screw and the tablet clamp into the ball head of the headrest bracket and fix them.

2. **Attach the tablet holder to the headrest.**

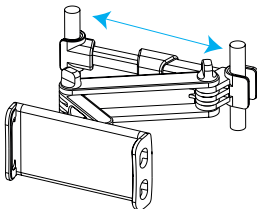

Mount the tablet holder to the bars of the car's headrest.

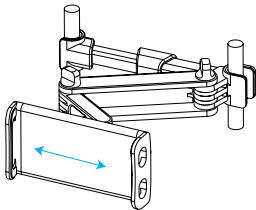

Place your tablet in the tablet clamp.



Please note: we don't accept liability for any damages on used devices. Please check compatibility of our product with the manufacturer of your device before use.

XLayer GmbH herewith explains that the device **XLayer Tablet holder for car headrests** is in accordance with all relevant requirements and guidelines. The declaration of conformity can be requested under service@xlayer.de.